



# GLACIÄR MIDI

Gas Leakage Detector for commercial and industrial applications



**ENG** **USER MANUAL**

# 1 INDEX

<b>1</b>	<b>INDEX</b>	<b>2</b>
<b>2</b>	<b>PRODUCT DESCRIPTIONS</b>	<b>4</b>
2.1	INTENDED USES / APPLICATIONS	4
2.2	PHYSICAL DIMENSIONS	5
<b>3</b>	<b>INSTALLATION</b>	<b>6</b>
3.1	GENERAL INFORMATION	6
3.2	INSTALLATION TIPS	6
3.2.1	Equipment rooms	6
3.2.2	Cold rooms	6
3.2.3	Chillers	7
3.2.4	Air conditioning - direct VRF/VRV systems	7
3.3	INSTALLATION	7
	Electrical connection	9
3.4	ADDITIONAL INSTALLATION NOTES	10
<b>4</b>	<b>OPERATION</b>	<b>10</b>
4.1	POWER ON	10
4.2	DEVICE OPERATING STATES	11
4.3	SETTING THE DEVICE USING THE ROTARY SWITCH	11
	Description of the rotary switch LEDs	13
	Possible configurations	13
	J6 voltage value conversion table / selected function	14
4.4	ANALOGUE OUTPUT	15
4.5	ALARM MANAGEMENT	16
	Alarm set points	16
4.6	MAGNETIC KEY FOR CONFIGURATION	17
4.6.1	Bluetooth activation	17
4.6.2	Alarm/warning management	17
4.7	SAMON GLACIÄR APP FEATURES	18
4.7.1	Connecting the device via Bluetooth	18
4.8	MODBUS® NETWORK	21
	Parameters for RS485 communication selectable via app or rotary switch	21
4.9	TABLE OF MODBUS® VARIABLES	22
	Function 04 Read Input Registers	22
	Function 06 Write Single Register & Function 16 Write Multiple Register	23
	Function 04 Read Input Registers	23
	Input register 302 bits	24
	Function 05 Write Single Coil & Function 01 Read Coils	24
<b>5</b>	<b>MAINTENANCE</b>	<b>25</b>
5.1	CALIBRATION PROCEDURE	25
5.2	CALIBRATION KIT	25
5.3	CALIBRATION VIA APP	26
5.4	CALIBRATION VIA MODBUS® COMMUNICATION	28
5.4.1	Diagram of the calibration procedure	29
5.4.2	Operation of the registers for calibration	30
5.5	SENSOR REPLACEMENT PROCEDURE	31
	Built-in version	31
	Remote version	31
5.6	CLEANING THE DEVICE	32

<b>6</b>	<b>FURTHER INFORMATION .....</b>	<b>32</b>
6.1	SENSOR OPERATING PRINCIPLE .....	32
6.1.1	Semiconductor sensors .....	32
6.1.2	Electrochemical sensors.....	32
6.1.3	Pre-calibrated sensors and devices .....	32
6.2	GAS DETECTED .....	33
6.3	TECHNICAL SPECIFICATIONS.....	34
6.3.1	Mechanical specification.....	34
6.4	DISPOSAL OF THE DEVICE .....	35
6.4.1	Disposal of electrical and electronic equipment.....	35
6.4.2	Disposal of the sensors.....	35
6.4.3	Conformity to standards.....	35
<b>7</b>	<b>ORDER INFORMATION .....</b>	<b>36</b>
7.1	GAS DETECTOR GLACIÄR MIDI SERIES PART NUMBERS .....	36
7.2	SENSOR ELEMENT PART NUMBERS .....	36
7.3	ACCESSORIES .....	36

## 2 PRODUCT DESCRIPTION

### 2.1 Intended use / Applications

The **GLACIÄR MIDI** series leakage detectors continuously monitor indoor air for any refrigerant leaks. The devices can be used for refrigeration applications (cold rooms, freezer rooms, machinery rooms).

The **GLACIÄR MIDI** series detectors are available in the following configurations:

- Built-in version
- Remote version

They are calibrated to detect most refrigerants currently available on the market. The sensitive elements are constructed using semiconductor (SC) technology, infrared (IR) technology, or electrochemical (EC) technology.

The **GLACIÄR MIDI** series detectors can be used in stand-alone applications or connected to **SAMON** controllers or third-party devices.

Communication with controllers uses an analogue output, relays, or an RS485 Modbus® serial connection.

When a refrigerant leakage exceeding a programmable concentration threshold is detected, an alarm or warning status is activated, depending on the level of concentration set, and the **GLACIÄR MIDI** responds as follows:

- The combination of LEDs that are on changes
- A dedicated internal relay (SPDT) is activated
- The analogue output is controlled (in proportion to the detected concentration)
- The change in status is signalled via the RS485 Modbus® output

Furthermore, the **"SAMON GLACIÄR" app**, available in both App Store and Play Store, can be used to access the device.

The **GLACIÄR MIDI** series detectors enable compliance with refrigeration safety standards (e.g., EN 378, ASHRAE 15) through alarms to alert personnel in the event of a refrigerant leakage.



**WARNING:** semiconductor sensors detect the gas they have been calibrated for, but are also sensitive to other types of gases, solvents, alcohol, or substances containing ammonia, such as cleaning products, present in the environment. This, in certain areas and applications, can lead to false alarms when the substances described above are present. Nonetheless, although they do not only detect the specific gas, but they also still give a reliable indication of the concentration of the gas they have been calibrated for.



**WARNING:** This device is neither certified nor approved for operation in oxygen-enriched atmospheres. Non-compliance can lead to EXPLOSION.



**WARNING:** This device has not been designed to guarantee intrinsic safety when used in areas classified as hazardous ("Directive 2014/34/EU ATEX" and "NFPA 70, Hazardous Location"). For operator safety, DO NOT use it in hazardous locations (classified as such).  
If the equipment is used in a manner not specified by the manufacturer, the protection provided by the equipment may be impaired.

**GLACIÄR MIDI** is available in five main versions:

- **Infrared version for CO<sub>2</sub>**
- **Electrochemical version for Ammonia**
- **Semiconductor version for R32 refrigerant gas blends**
- **Semiconductor version for HC refrigerant gases**
- **Semiconductor version for HFC/HFO refrigerant gases**

## 2.2 Physical dimensions

**Built-in version**

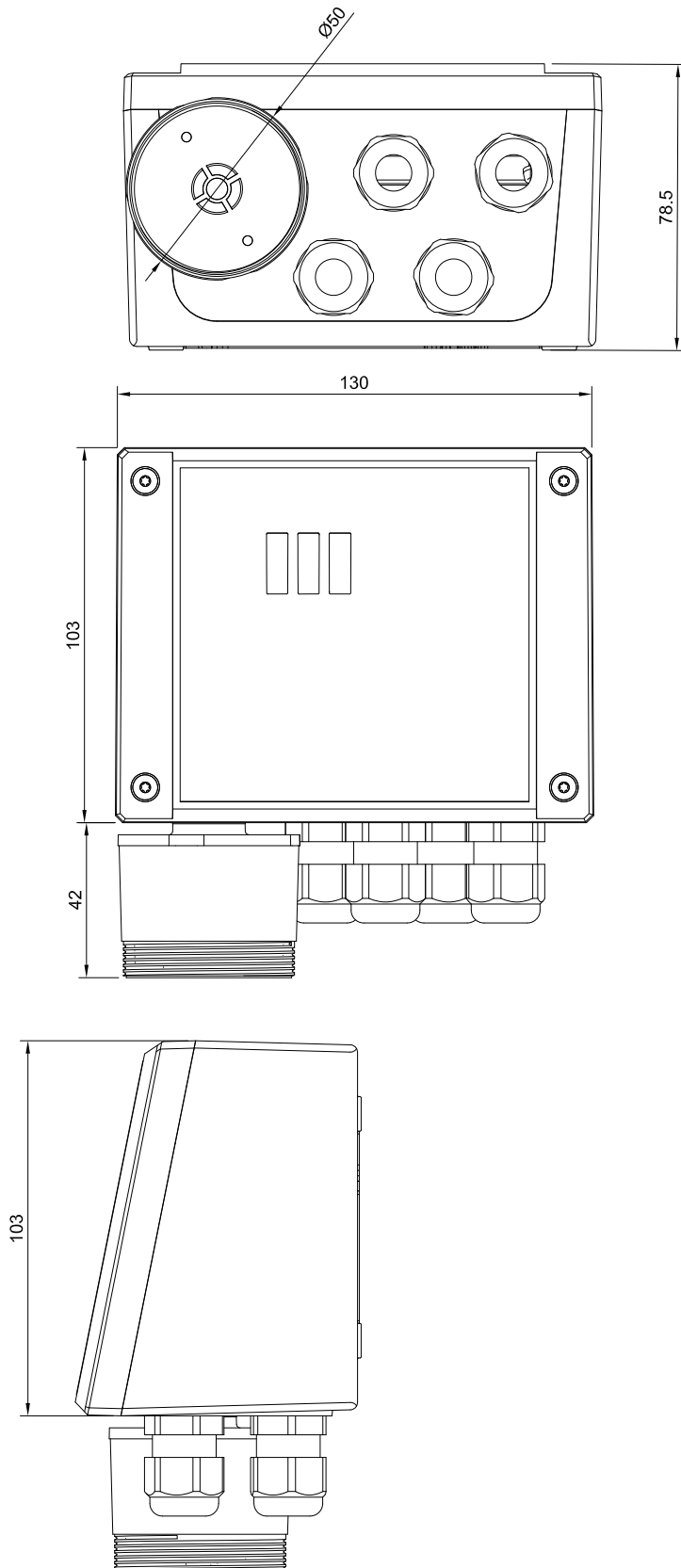

**Remote version**

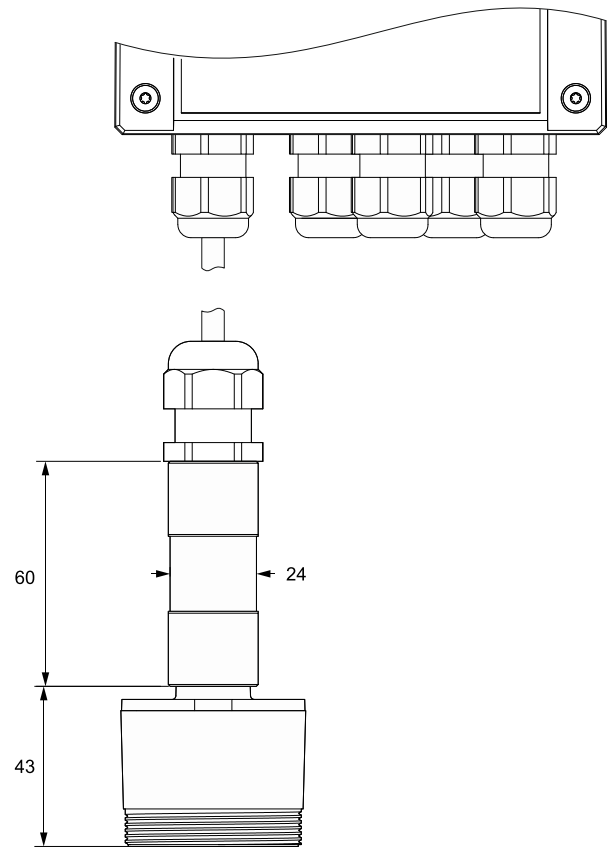

## 3 INSTALLATION



**IMPORTANT:** the gas detector must only be installed by qualified personnel. It is recommended to read the manual completely in order to use the product correctly.

### 3.1 General information

The performance and overall effectiveness of the system strictly depend on the characteristics of the place where the gas detector is installed. It is therefore necessary to scrupulously comply with and carefully analyse every detail of the installation process, including (but not limited to) the following aspects:

- local, state and national regulations and standards governing the installation of gas monitoring equipment
- electrical standards governing the laying and connection of power and signal cables to gas monitoring equipment
- all possible environmental conditions that the devices will be exposed to
- the physical characteristics of the gas to be detected (in particular, its specific weight)
- the characteristics of the application (e.g., possible leakages, movement of air, areas where gas may stagnate, high pressure areas, etc.)
- the accessibility needed for routine maintenance and repairs
- the types of equipment and accessories needed to manage the system
- any limiting factors or regulations that may affect system performance or installations.



**IMPORTANT:** the installation surfaces must not be exposed to continuous vibrations so as to prevent damage to the connections and electronic devices.

### 3.2 Installation tips



**CAUTION:** THERE IS NO GENERAL RULE for establishing the appropriate number of sensors and their location for each application. Therefore, the guidelines described below are intended as support for installers, and not as rules in their own right. **SAMON accepts no liability for the installation of the gas detectors.**

#### 3.2.1 Sensor height

Gas type	Mounting height
NH <sub>3</sub> Ammonia (R-717)	20 cm below ceiling
HFC / HFO / C <sub>3</sub> H <sub>8</sub> Propane (R290)	20 cm above the floor
CO <sub>2</sub> Carbon Dioxide (R744)	20 cm above the floor

#### 3.2.2 Equipment rooms

In equipment rooms, the gas detectors can be installed as follows:

- Position the gas detectors near areas with a high concentration of refrigerant, such as compressors, cylinders, storage tanks, pipes and conduits. Avoid vibrating surfaces.
- Position the gas detectors near mechanical parts such as pressure reducers, valves, flanges, joints (brazed or mechanical) and pipes. In particular, above or below these in relation to the type of gas (see below).
- Position the gas detectors around the perimeter of the room, so as to completely surround the equipment.
- Position the gas detectors in all enclosed areas (stairwells, pits, enclosed corners, etc.) where pockets of stagnant gas may form.
- Position the gas detectors near ventilation air flows, both natural and mechanical (if present).
- Do not place the gas detectors too close to areas with high-pressure gas, to allow this to spread in the space around the gas detector. Otherwise the device may not detect the refrigerant leak if the flow of gas is too fast.

#### 3.2.3 Cold rooms

In cold rooms, position the gas detectors near the return air flow from the evaporator, ideally on a side wall, but not directly in front of the evaporator.

Where there are several evaporators, it may be possible to use one gas detector for every two evaporators if their positioning allows.

Finally, position the gas detectors near mechanical parts or joints such as valves, flanges, and pipes, avoiding areas with high-pressure gas.

### 3.2.4 Chillers

Measuring leaks on outdoor chillers is generally more difficult, given the highly variable air flow.

Generally, it is recommended to install the gas detectors near the compressor, as this is the place where refrigerant leaks are most likely to occur. In particular, check if it is possible to install the gas detector inside the closed unit near the compressor, where gas is more likely to stagnate. However, avoid vibrating surfaces or surfaces that are difficult to access for maintenance.

It is also recommended to install gas detectors along the ventilation system, especially in the event of low or variable air flow speeds.

### 3.2.5 Air conditioning - direct VRF/VRV systems

In air-conditioned buildings, it is recommended to install at least one gas detector in each room, identifying the areas of greatest risk, such as air flows from ventilation systems and heating systems such as radiators.

In these spaces, the refrigerant gas is usually denser than air: consequently, the gas detectors should be installed close to the floor.

Also consider installing the gas detector in ceilings or false ceilings, if not adequately sealed. Do not install the gas detectors underneath mirrors/washbasins and inside bathrooms.

Do not install the gas detectors near sources of steam.

## 3.3 Installation

Once the optimal position to install the sensor has been chosen, it is recommended to install the sensor (identifiable on the device by the black sensor housing) in a vertical position, with the sensitive element (black part) facing downwards. The sensor can now be mounted on the wall, as follows:

- Drill the holes in the wall using the measures on the bottom side of the detector (shown in the picture below).
- Fix the device using four screws, chosen according to the type of installation and the type of wall, maximum diameter 4 mm, minimum length 15 mm and torque 2,5 Nm.
- Fix the remote sensor using one screw, chosen according to the type of installation and the type of wall, maximum diameter 4 mm, minimum length 15 mm and torque 2.5 Nm.

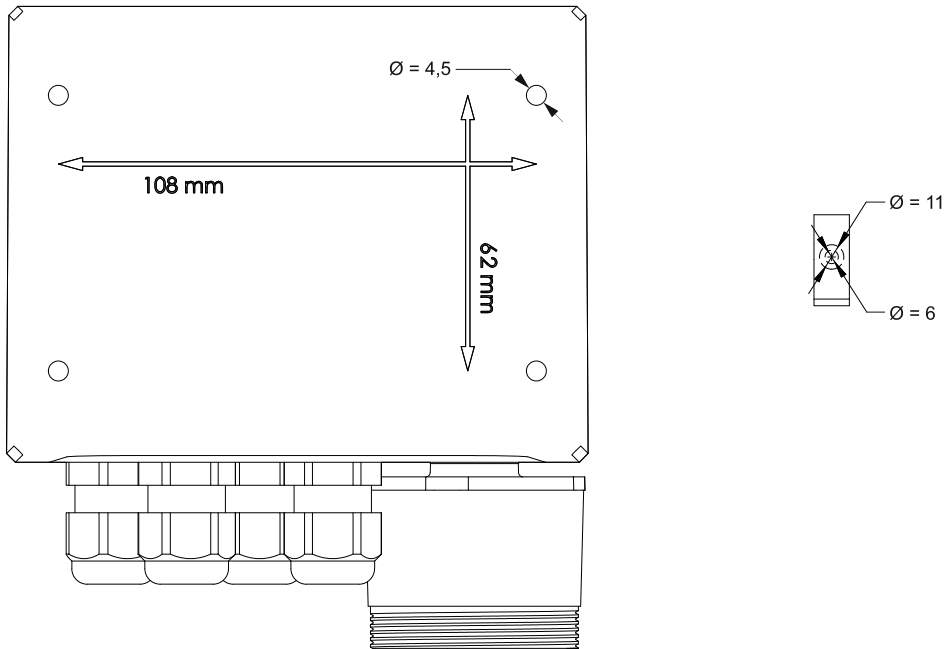

- Open the cover of the **GLACIÄR MIDI**, fit the cable glands and make the required electrical connections. The plug-in terminals can be removed from the device to facilitate wiring.

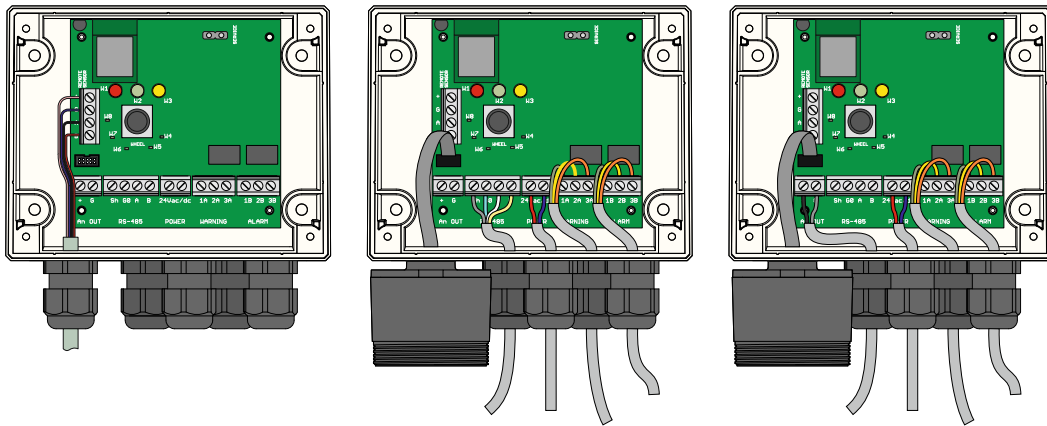

- Power the device on and complete the settings using the rotary switch, as described in the following paragraphs, or using the app, as described below or through the Modbus connection.
- Use the cable glands provided to pass through and connect the cables to the terminals, as shown in the figure and in the connection table below. The terminals can be removed to simplify wiring.
- Close the cover
- Cord range for M16 cable gland 5 - 10 mm, for M20 cable gland 7.5 - 11.3 mm
- Use UL listed approved cable, min. 50°C, suitable for electrical rating in application
- Tighten the cable glands with a torque of 2,5 Nm
- Close the cover.



**Electrical connection**

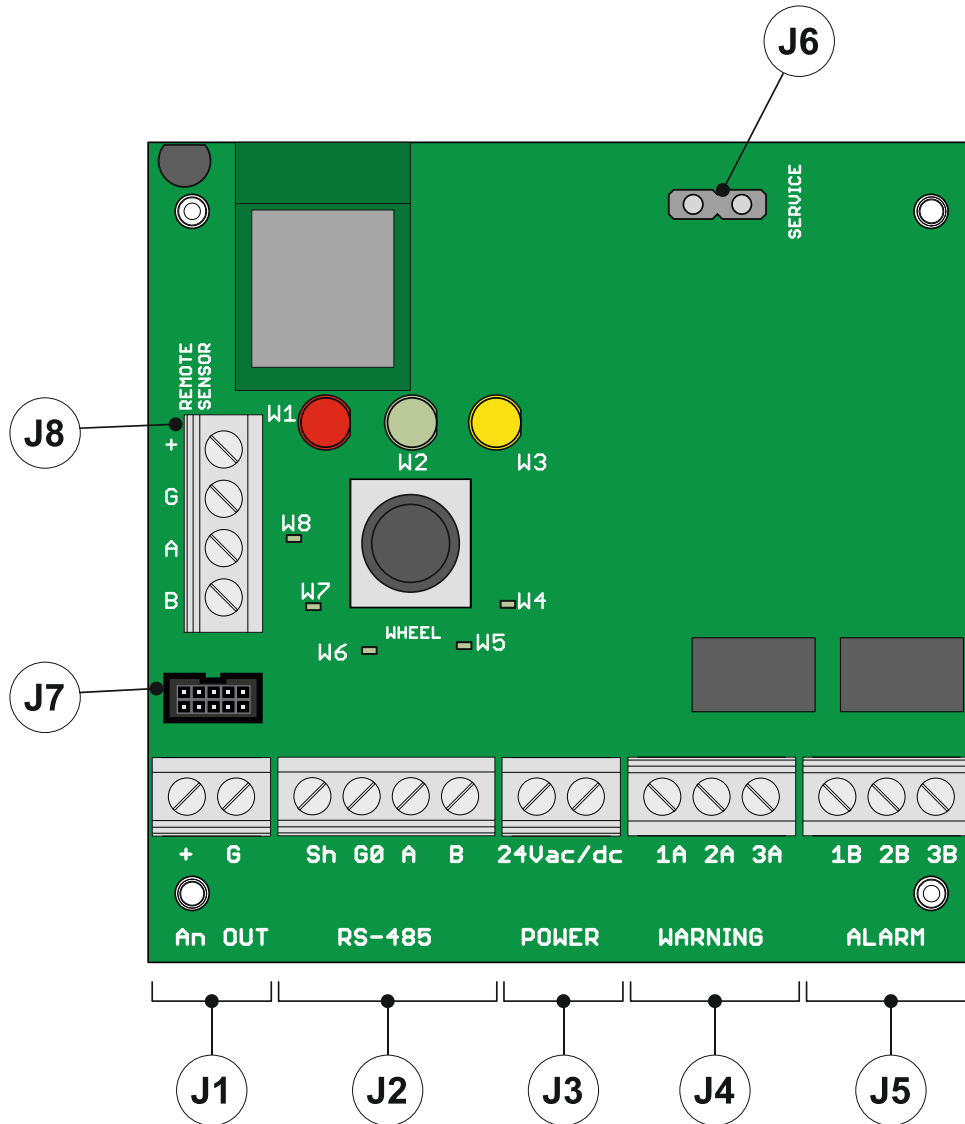

<b>J1</b>	+	Analogue output
	G	Analogue output reference
<b>J2</b>	Sh	Shielded RS485 cable
	G0	GND for RS485
	A	Tx + / Rx + for RS485
	B	Tx- / Rx- for RS485
<b>J3</b>	+24 Vac/dc	For Vac power supply, connect the second transformer wire
	+24 V AC/DC	For Vdc power supply, connect one of the two power wires, the device automatically recognizes whether this is + or GND. For AC power supply, connect one of the two transformer wires.
<b>J4</b>	1A	NO contact for the warning/fault relay
	2A	Common for the warning/fault relay
	3A	NC contact for the warning/fault relay
<b>J5</b>	1B	NO contact for the alarm relay
	2B	Common for the alarm relay
	3B	NC contact for the alarm relay
<b>J6</b>	+	V+ for the output voltage provided for service
	G	Service voltage reference
<b>J7</b>	/	Built-in version sensor connector
<b>J8</b>	/	Remote version sensor connector (connection not to be used for built-in products)

All external circuits connected to device shall be double or reinforced isolated from mains meet SELV and Limited energy requirements according to clause 9.4 of UL61010-1 3rd edition.

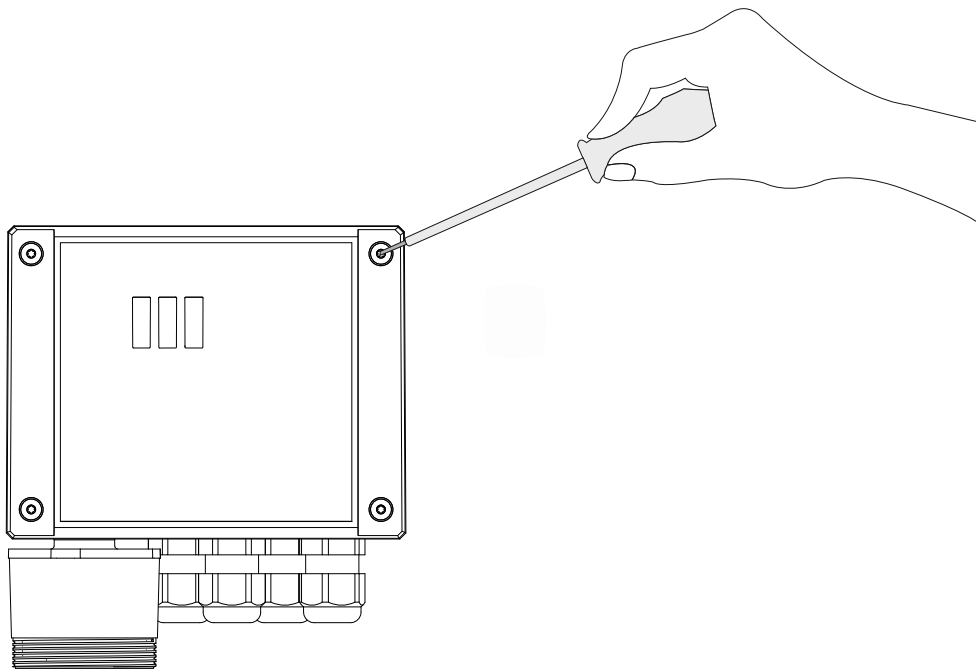

- Secure the detector cover with the four screws.
- Power the device on and set the parameters using the “**SAMON GLACIÄR**” app (see the relevant chapter) if the settings were not previously made using the rotary switch.

### 3.4 Additional installation notes

Before commencing electrical installation and wiring, carefully read the following notes:

- Power must be supplied by a safety isolation transformer (Class 2) with no earth connection on the secondary winding.
- The cable for the relays must be sized and fitted with fuses based on the rated voltages, currents, and environmental conditions.
- If stranded wires are used, it is recommended to use an end terminal.
- To comply with RFI immunity regulations, the communication cable shield on the supervisor must be earthed (e.g., to the chassis, earth bar, etc.)
- Complete all wiring before powering on.

## 4 OPERATION

### 4.1 Power on

When power is connected, the device begins the start-up cycle, divided into two phases:

- start-up
- warm-up

The start-up sequence lasts around 20 seconds, during which the main functions of the gas detector are initialized and verified. In this phase, the LEDs on the front panel are activated in sequence, and the device cannot yet be used. At the end of the start-up sequence, the warm-up phase commences, during which the sensor output signal is adjusted and stabilized. In this phase, the device can be used to detect gas and installation can be completed via the rotary switch, app or controller; nonetheless, the measurement is less reliable, and calibration is not possible.

During the warm-up phase, the green LED flashes around twice every second. The duration of the warm-up phase depends on the sensor technology used:

- Semiconductor = 5 min
- Electrochemical = 5 min
- Infrared = 2 min

The duration of the warm-up phase may also vary according to environmental conditions. In this phase it is important not to cause sudden changes in gas concentration, so as to avoid compromising correct measurement by the sensor.



**IMPORTANT:** the sensors may take longer to warm up than specified; in these cases, do not take any action, wait for the device to stabilise. The time needed for complete stabilisation of the device may vary from 2 hours (minimum time) to 24 hours (recommended time).

## 4.2 Device operating states

The **GLACIÄR MIDI** series gas detectors provide visual indications of their current operating status, in addition to the relay outputs. Visual indication of device operating status is provided by three LEDs (green/red/orange). Device status and the corresponding outputs are shown in the following table:

Status	LED	Warning/Fault relay	Alarm relay
Warm-up		OFF	OFF
Normal		OFF	OFF
Bluetooth		OFF	OFF
Serial connected	Internal LED W8 on steady	---	---
Warning delay		OFF	OFF
Alarm delay (RWF* = 0)		ON	OFF
Alarm delay (RWF* = 1)		OFF	OFF
Warning (RWF* = 0)		ON	OFF
Warning (RWF* = 1)		OFF	OFF
Alarm (RWF* = 0)		ON	ON
Alarm (RWF* = 1)		OFF	OFF
Fault (RWF* = 0)	 Red and yellow on steady Green LED OFF	ON	ON
Fault (RWF* = 1)	 Red and yellow on steady Green LED OFF	ON	OFF

\*RWF = Relay WF Modbus register

### 4.3 Setup of the device using the rotary switch

The rotary switch (R1) is located inside the device, on the electronic board .

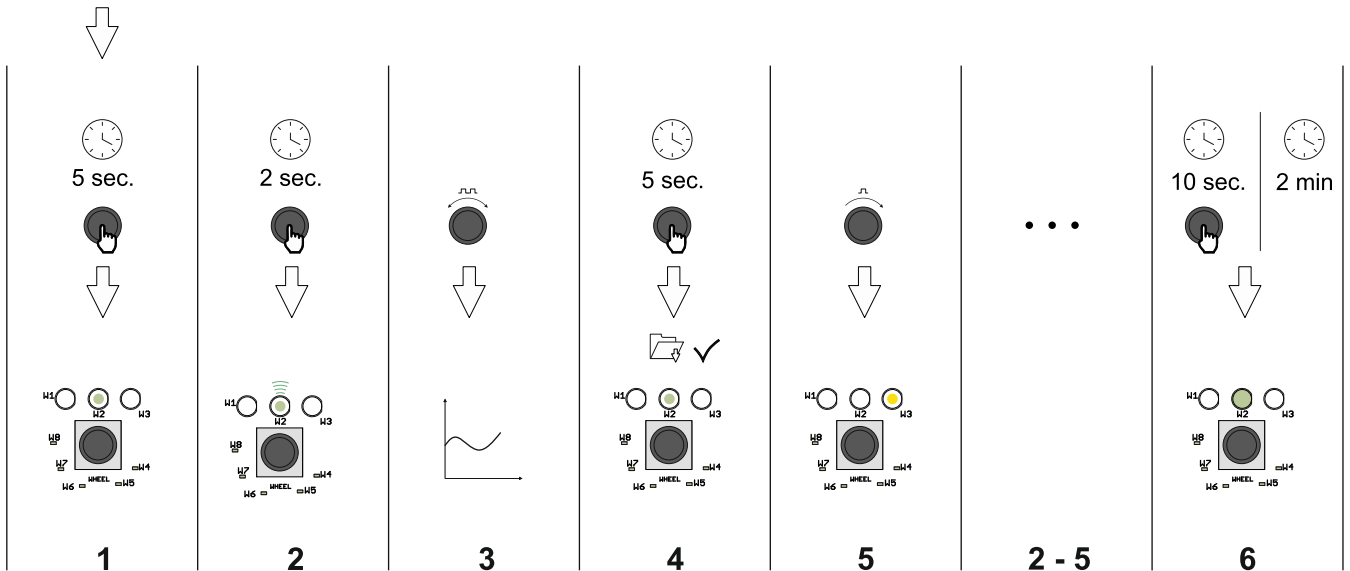
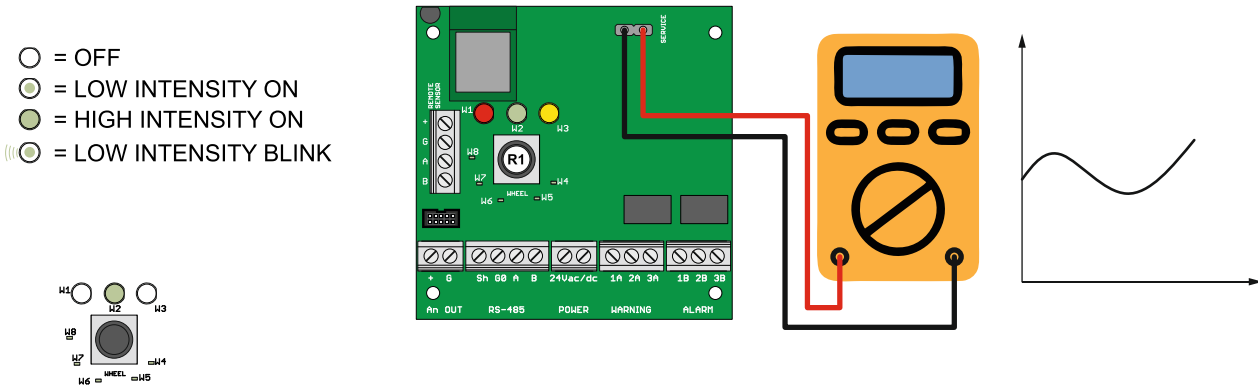

The basic configuration can be performed using the rotary switch, following the instructions described below. To complete the configuration, a digital multimeter is required, with the test leads connected to connector J6. In this way, the tester will show a voltage between 0 and 10 Volts, indicating the value selected by the rotary switch. The meaning of the voltage value displayed changes depending on the selected function: the table below shows the meaning of each voltage for each function.

Setting mode is activated by pressing and holding the rotary switch for 5 seconds. The LED that is ON acts as the menu point, indicating which parameters will be set (all the other LEDs are OFF). Turn the switch to select the parameter to be set. Reading the table, the voltage read with a voltmeter connected to the service terminal indicates the chosen setting. Pressing the rotary switch for 2 seconds accesses the selected parameter. The corresponding LED flashes. Turning the rotary switch changes the parameter setting.

After having made the setting, pressing the rotary switch for 5 seconds saves the new value. Turning the rotary switch again moves to the next parameter.

After two minutes of inactivity or pressing the rotary switch for 10 seconds, the detector returns to normal operating mode.

### **Description of the rotary switch LEDs**

The table below shows the value of the selected parameter and the corresponding voltage value. Each LED corresponds to a different parameter. The default parameter values are saved to permanent memory.

<b>LED W1</b>	Not used
<b>LED W2</b>	Warning level. The operator can set the warning threshold. See the table below for the voltage value corresponding to the selected setting.
<b>LED W3</b>	Alarm level The operator can set the alarm threshold. See the table below for the voltage value corresponding to the selected setting.
<b>LED W4</b>	Modbus address The operator can set the Modbus address. To set the values with greater precision, use the Modbus serial connection or app. See the table below for the voltage value corresponding to the selected setting.
<b>LED W5</b>	Alarm delay The operator can select the delay time for activation of the LED and the alarm relay after the alarm threshold has been exceeded. See the table below for the voltage value corresponding to the selected setting.
<b>LED W6</b>	Type of analogue output voltage. The operator can select the type of analogue output. See the table below for the voltage value corresponding to the selected setting.
<b>LED W7</b>	Alarm/warning reset function mode This parameter is used to select the warning and alarm reset modes. 0 = manual reset (latch) / 1 = automatic reset
<b>LED W8</b>	Modbus configuration The operator can choose the desired Modbus configuration from the options available. See the table below for the voltage value corresponding to the selected setting.

### **Possible configurations - Alarm/warning reset function mode (W7)**

<b>W=0</b> <b>A=0</b>	Manual reset Warning	Manual reset Alarm
<b>W=1</b> <b>A=0</b>	Automatic reset Warning	Manual reset Alarm
<b>W=0</b> <b>A=1</b>	Manual reset Warning	Automatic reset Alarm
<b>W=1</b> <b>A=1</b>	Automatic reset Warning	Automatic reset Alarm

**J6 voltage value conversion table / selected function**

Service wheel LED	W2 / W3				W4	W5	W6	W7	W8
	Full scale 1000	Full scale 4000	Full scale 10000	Full scale 100					
Voltage [V]	[ppm]	[ppm]	[ppm]	[ppm]	[--]	[m]	[--]	[--]	[--]
0	0	0	0	0	0	0			
0,1	100	100	100		1	1			
0,2	200	200	200		2	2			
0,3	300	300	300		3	3			
0,4	400	400	400		4	4			
0,5	500	500	500	5	5	5			
0,6	600	600	600		6	6			
0,7	700	700	700		7	7			
0,8	800	800	800		8	8			
0,9	900	900	900		9	9			
1	1000	1000	1000	10	10	10			9600 8N1
1,1		1100	1100		11	11			
1,2		1200	1200		12	12			
1,3		1300	1300		13	13			
1,4		1400	1400		14	14			
1,5		1500	1500	15	15	15			
1,6		1600	1600		16	16			
1,7		1700	1700		17	17			
1,8		1800	1800		18	18			
1,9		1900	1900		19	19			
2		2000	2000	20	20	20	4-20 mA	W=0 A=0	9600 8N2
2,1		2100	2100		21				
2,2		2200	2200		22				
2,3		2300	2300		23				
2,4		2400	2400		24				
2,5		2500	2500	25	25				
2,6		2600	2600		26				
2,7		2700	2700		27				
2,8		2800	2800		28				
2,9		2900	2900		29				
3		3000	3000	30	30				19200 8N1
3,1		3100	3100		31				
3,2		3200	3200		32				
3,3		3300	3300		33				
3,4		3400	3400		34				
3,5		3500	3500	35	35				
3,6		3600	3600		36				
3,7		3700	3700		37				
3,8		3800	3800		38				
3,9		3900	3900		39				
4		4000	4000	40	40				19200 8N2
4,1			4100		41				
4,2			4200		42				
4,3			4300		43				
4,4			4400		44				
4,5			4500	45	45				
4,6			4600		46				
4,7			4700		47				
4,8			4800		48				
4,9			4900		49				
5			5000	50	50		1-5 V	W=1 A=0	
5,1			5100		51				
5,2			5200		52				
5,3			5300		53				
5,4			5400		54				
5,5			5500	55	55				
5,6			5600		56				
5,7			5700		57				
5,8			5800		58				
5,9			5900		59				
6			6000	60	60				9600 8E1
6,1			6100		61				
6,2			6200		62				
6,3			6300		63				

Service wheel LED	W2 / W3				W4	W5	W6	W7	W8
	Full scale 1000	Full scale 4000	Full scale 10000	Full scale 100					
Voltage [V]	[ppm]	[ppm]	[ppm]	[ppm]	[--]	[m]	[--]	[--]	[--]
6,4			6400		64				
6,5			6500	65	65				
6,6			6600		66				
6,7			6700		67				
6,8			6800		68				
6,9			6900		69				
7			7000	70	70				19200 8E1
7,1			7100		71				
7,2			7200		72				
7,3			7300		73				
7,4			7400		74				
7,5			7500	75	75				
7,6			7600		76				
7,7			7700		77				
7,8			7800		78				
7,9			7900		79				
8			8000	80	80		2-10 V	W=0 A=1	9600 8O1
8,1			8100		81				
8,2			8200		82				
8,3			8300		83				
8,4			8400		84				
8,5			8500	85	85				
8,6			8600		86				
8,7			8700		87				
8,8			8800		88				
8,9			8900		89				
9			9000	90	90				19200 8O1
9,1			9100		91				
9,2			9200		92				
9,3			9300		93				
9,4			9400		94				
9,5			9500	95	95				
9,6			9600		96				
9,7			9700		97				
9,8			9800		98				
9,9			9900		99				
10			10000	100	100		0-10 V	W=1 A=1	

## 4.4 Analogue output

The GLACIÄR MIDI series gas detectors feature a single configurable analogue output. During normal operation, the device's analogue output signal is proportional to the gas concentration measured, and can be selected from the following options:

- 1 to 5 V
- 2 to 10 V
- 0 to 10 V
- 4 to 20 mA (default)

The GLACIÄR MIDI series gas detectors use different voltage/current values to indicate different operating modes. In normal operation, the gas concentration is indicated by the analogue output signal level. The relationship between output signal level and gas concentration is shown below:

Gas concentration	1-5 V	2-10 V	0-10 V	4-20 mA
Underrange				2 mA
0%	1 V	2 V	0 V	4 mA
50%	3 V	6 V	5 V	12 mA
100%	5 V	10 V	10 V	20 mA
Overrange				22 mA

## 4.5 Alarm management

The alarms are activated when the set thresholds are exceeded. The alarm threshold value must always be greater than the warning value. The alarm and warning thresholds must be less than or equal to the full-scale range and must be greater than or equal to the allowed limit. The alarms are activated when the set thresholds are exceeded.

### Alarm set points

Sensor, gas and range	Minimum value	Alarm default	Warning default	Maximum value	Unit of measure
SC, HFC/HFO 0-1000 ppm	150	500	150	800	ppm
SC, R290, 0-4000 ppm	400	800	400	3000	ppm
IR, CO <sub>2</sub> , 0-10000 ppm	1000	5000	1500	8000	ppm
EC, NH <sub>3</sub> , 0-100 ppm	15	30	15	80	ppm

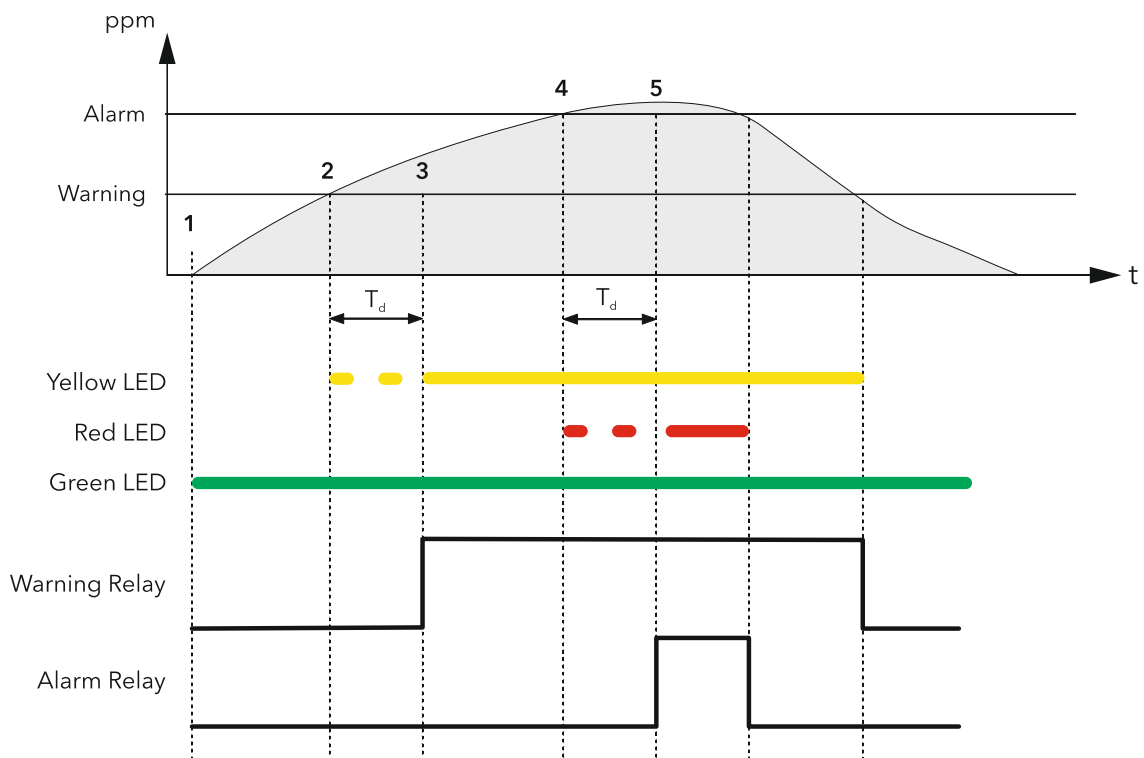

1	2	3	4	5
300 PreAlarmflag = 0	300 PreAlarmflag = 0	300 PreAlarmflag = 0	300 PreAlarmflag = 1	300 PreAlarmflag = 1
307 PreWarningFlag = 0	307 PreWarningFlag = 1	307 PreWarningFlag = 1	307 PreWarningFlag = 1	307 PreWarningFlag = 1
308 WarningFlag = 0	308 WarningFlag = 0	308 WarningFlag = 1	308 WarningFlag = 1	308 WarningFlag = 1
309 AlarmFlag = 0	309 AlarmFlag = 0	309 AlarmFlag = 0	309 AlarmFlag = 0	309 AlarmFlag = 1
Yellow LED OFF	Yellow LED flashing	Yellow LED ON	Yellow LED ON	Yellow LED ON
Red LED OFF	Red LED OFF	Red LED OFF	Red LED flashing	Red LED ON
Warning relay OFF	Warning relay OFF	Warning relay ON	Warning relay ON	Warning relay ON
Alarm relay OFF	Alarm relay OFF	Alarm relay OFF	Alarm relay OFF	Alarm relay ON



## 4.6 Magnetic key for configuration

The device is supplied with a magnet for configuration. By placing it in the slot provided, the following functions can be managed:

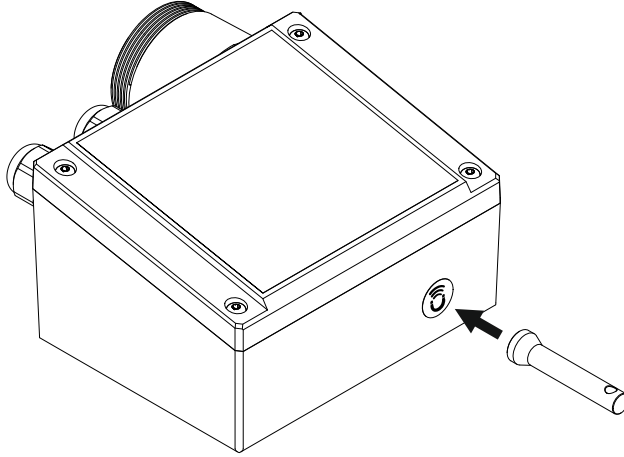

### 4.6.1 Bluetooth activation

After 5 seconds of exposing the magnet to the magnetic sensor, Bluetooth mode is activated. If Bluetooth is already on, after 5 seconds of exposure Bluetooth is deactivated.

Bluetooth mode is automatically deactivated after 20 minutes of inactivity. Product operation in Bluetooth mode is indicated by the rapid flashing of the green LED.

Bluetooth Activation is used to set up the product on installation and/or enter maintenance mode. When in this mode, the alarms (if present) are disabled until the normal operating mode is restored, deactivating Bluetooth.

### 4.6.2 Alarm/warning management

If a warning or alarm is active, after 2 seconds of exposure, the alarm will be acknowledged and deactivated. If gas is still present, the detector will enter alarm or warning mode as usual, after a 10-second delay.

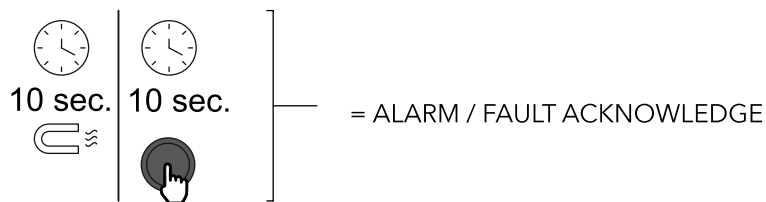

## 4.7 SAMON GLACIÄR app features

The "**SAMON GLACIÄR**" app lets users fully exploit the potential of the new **GLACIÄR MIDI** series gas detectors, allowing simple and intuitive interaction with the gas detector. This simplifies configuration by using a smartphone to interface with the **GLACIÄR MIDI** gas leakage detectors.

The **SAMON GLACIÄR app** is available on the ANDROID store and on the IOS App Store.



**SAMON GLACIÄR** can be used to perform the following functions:



- Configuration: modify alarm thresholds, configure Modbus settings, modify relay behaviour, and manage analogue output settings
- Maintenance: check correct functioning of the device
- Calibration, complete with calibration report
- Display of current gas concentration measurement and indication of alarm/fault status

### 4.7.1 Connecting the device via Bluetooth

Before connecting to the device via the **SAMON GLACIÄR app**, first make sure that the BLUETOOTH connection and GEOLOCATION are enabled on the smartphone used (Android only).

Make sure that Bluetooth mode has been activated on the **GLACIÄR MIDI** using the magnetic key, as described in the previous chapter.

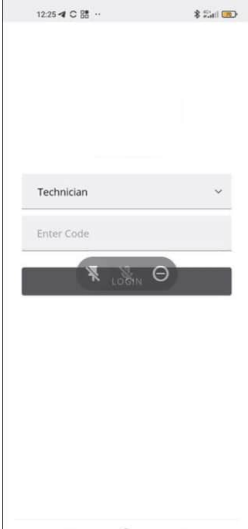
Open the **SAMON GLACIÄR app** (previously downloaded); the following screen is displayed.

Login screen	Bluetooth connection screen
	
<p>Select:</p> <ul style="list-style-type: none"><li>• Operator, to continue displaying the gas detector variables and parameters.</li><li>• Technician, for password access and the possibility to set the parameters and variables.</li></ul> <p>The password to unlock the device is <b>2222</b>.</p>	<p>If all the functions described above have been enabled on the smartphone and the GLACIÄR MIDI is in Bluetooth mode, the available devices are shown on the app screen. If this is not the case, touch the app screen to refresh the display. Verify that the serial number on the label of the device being connected matches the one displayed on the screen.</p> <p>Select the correct device and verify correct connection. The Bluetooth symbol at the top right changes from red to green.</p>

### Home screen

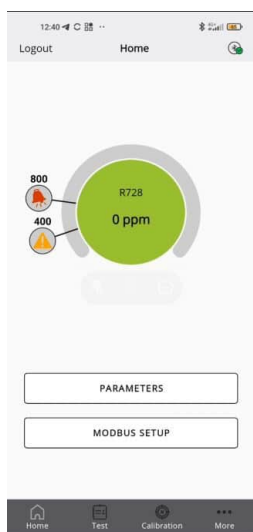

From the home screen, it is possible to display the current concentration level measured by the sensor, with the corresponding alarm and warning thresholds.

The following screens can also be accessed:

- PARAMETERS
- MODBUS SETUP
- Test
- Calibration
- More

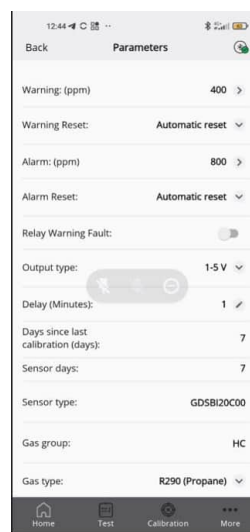

### PARAMETERS screen



This screen displays the sensor parameters. It is also possible to select the type of gas to be detected, from those that are compatible with the sensor. See the other information chapter in this manual for further details.

The following parameters can be displayed and modified if the user is logged with Technician access:

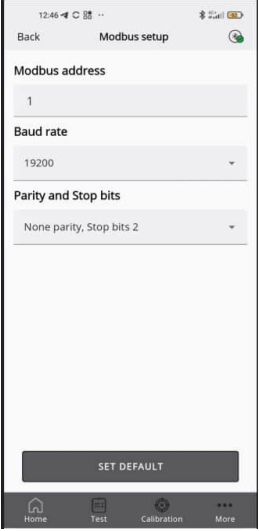
- Warning (ppm): Threshold for activating Warning.
- Warning Reset: Determines if Warning will revert to IDLE automatically if gas levels drop below Warning threshold or requires manual acknowledgement to be reset.
- Alarm (ppm): Threshold for activation of Alarm.
- Alarm Reset: Determines if Alarm will revert to IDLE automatically if gas levels drop below Alarm threshold or requires manual acknowledgement to be reset.
- Relay Warning Fault (RWF): Activate to turn Warning relay into a dedicated fault relay.
- Output type: Choose analog output scale for J1. Mode description in section 4.4 (Insert reference).
- Alarm delay: The delay in minutes from the measured concentration passes the threshold value to the moment the alarm activates. Affect both Warning and Alarm.
- Gas type: The specific gas to be measured.

MODBUS SETUP screen	Test mode screen
	
<p>The following parameters can be set:</p> <ul style="list-style-type: none"> <li>• Modbus address</li> <li>• Baud rate</li> <li>• Parity and stop bits.</li> </ul> <p>Pressing SET DEFAULT sets the default parameters shown in the table in the Modbus setup paragraph (Does not affect the Modbus address.).</p>	<p>If enabled, the following functions can be activated in test mode, i.e. not corresponding to the behaviour of the device, rather for debugging:</p> <ul style="list-style-type: none"> <li>• Warning relay</li> <li>• Alarm relay</li> <li>• Green LED</li> <li>• Red LED</li> <li>• Yellow LED</li> <li>• Analogue output</li> </ul>

More screen

<p>Displays the app technical and legal information.</p> <ul style="list-style-type: none"> <li>• App settings, change the unit of measure for the temperature displayed in the app</li> <li>• Device Info, view information on the currently connected device</li> <li>• Create report: to make a copy of the most recent report generated</li> <li>• Change logo, to replace the default logo that is shown on the calibration certificate with a different one</li> <li>• Third party license, see information on the third-party licenses used.</li> </ul>



**IMPORTANT:** the Calibration screen is explained in detail in paragraph 5.2 CALIBRATION VIA APP.

## 4.8 Modbus® network

For the Modbus RS485 network, use a shielded 3-wire cable. Recommended: Belden 3106A (or equivalent).

The Modbus communication parameters can only be set using the **SAMON GLACIÄR app** or the rotary switch on the device's electronic board.

Make sure that the network communication parameters are configured in the same way, including on the controller. To ensure optimal operation of the serial network, observe the following guidelines:

- make sure that the devices are configured with a single bus layout. Connecting several buses in parallel or branching several devices from the main bus may introduce incorrect combinations of signal impedance, reflections and/or distortions.
- Avoid using excessively long connections when connecting devices to the serial bus. The device - bus connection must not exceed a maximum length of 100 metre.
- Make sure that the polarity of the A / B signal is maintained across the serial network.
- Earth the cable shield only on the main unit side.
- Connect the cable shield to terminal SH on the gas detector.
- Make sure that the shield is intact across the serial network.
- Do not use the shield connection as a signal reference. Use a cable that provides a dedicated wire for the signal reference.
- Connect the signal reference to terminal GND on the gas detector.

The **GLACIÄR MIDI** series gas detectors feature a Modbus RTU digital interface. All of the status messages and most of the parameters accessible and/or configurable via the Bluetooth® interface are also accessible and/or configurable via MODBUS controller.

### ***Parameters for RS485 communication selectable via app or rotary switch***

Parameter	Possible values	Default value
Address	0 to 247 via app 0 to 100 via device	0
Baud rate	9600 or 19200	19200
Stop bits	1 or 2	2
Parity	None, Even or Odd.	None



**IMPORTANT:** Each device connected to the same RS485 bus must have its own address, otherwise there will be conflicts in transmission/reception that prevent serial communication.



**IMPORTANT:** The write registers are password-protected. By entering the password in the appropriate register, authorisation to write the variables will be provided for 15 minutes. There is a specific variable that indicates whether or not the device is currently locked.

The password to unlock the device is **2222**.

## 4.9 Table of Modbus® variables

### Function 04 Read Input Registers

Address	Register name	Short description	Medium description	Long description	Max value	Min value	Unit of meas.	Modbus Bit pos.	Modbus length	Default value
101	Concentration	Concentration ppm	Sensor concentration in "units"	Sensor concentration in "units"	65535	0		0	16	
102	Status_0	No ICM contact	No contact with the sensor module (ICM)	No contact with the sensor module (ICM)	1	0		0	1	
102	Status_1	No response from the sensor	Sensor module (ICM) signals no contact with the sensor	Sensor module (ICM) signals no contact with the sensor	1	0		1	1	
102	Status_4	Over range	Sensor over range	Sensor over range	1	0		4	1	
102	Status_5	Under range	Sensor under range	Sensor under range	1	0		5	1	
103	Range	Full scale	Sensor full scale	Sensor full scale	65535	0	ppm	0	16	
105	DaysOnline	DaysOnline	Number of days online	Number of days online	65535	0	day	0	16	
106	ModbusAddress	Modbus address	Detector Modbus address	Detector Modbus address	247	0		0	16	0
107	SWVer	SWVer	Firmware version	Firmware version	65535	0		0	16	
108	MachineCode	MachineCode	MachineCode	MachineCode	65535	0		0	16	
113	HWVer	HWVer	Hardware version	Hardware version	39321	0		0	16	
114	SensorType	Sensor type	Sensor cross-reference table value	Sensor cross-reference table value	999	0		0	16	
115	Units	Units	Sensor concentration unit	Sensor concentration unit	999	0		0	16	
116	AnalogOutputValue	Analogue output	Analogue output value	Analogue output value as a percentage	100	0	%	0	16	
117	GasGroup	Gas Group	Gas group listed in the table	1 R32 mixtures, 2 HFC/HFO, 3 HC, 4 CO2, 5 NH3	5	1		0	16	
118	DaysSinceService	Days since service	Days since last service performed	Days since last service performed	65535	0	day	0	16	
119	MaxDaysOnline	Max days online	Maximum number of days online allowed for the sensor	Maximum number of days online allowed for the sensor before replacement is required	65535	0	day	0	16	
120	MaxDaysToService	Max days to service	Maximum days until next service	Maximum days until next service	65535	0	day	0	16	365

**Function 06 Write Single Register & Function 03 Read Holding Registers**

Address	Register name	Short description	Medium description	Long description	Max value	Min value	Unit of meas.	Modbus Bit pos.	Modbus length	Default value
200	LimitAlarm	Alarm limit	Alarm threshold	Alarm threshold	10000	0	ppm	0	16	
201	Delay	Delay	Delay before alarm activation	Delay before alarm activation	20	0	min	0	16	0
203	LimitWarning	Warning limit	Warning threshold	Warning threshold	10000	0	ppm	0	16	
204	AnalogOutputType	Type of analogue output	Type of analogue output signal	2 = 4-20mA ; 5 = 1-5V ; 8 = 2-10V ; 10 = 0-10V	10	2		0	16	2
205	PassCode	PassCode	Password to authorise the next command	Password to authorise the next command	65535	0		0	16	
206	GasType (*)	Type of gas	Gas type value	Gas type value	50	0		0	16	
655	SpanConcentration	SpanConcentration	Span concentration for calibration	Span concentration for calibration	10000	0	ppm	0	16	0

**Function 02 Read Input Status**

Address	Register name	Short description	Medium description	Long description	Max value	Min value	Unit of meas.	Modbus Bit pos.	Modbus length	Default value
300	PreAlarmFlag	Alarm flag	Indicator of whether the alarm threshold has been exceeded	1 = alarm threshold exceeded	1	0		0	1	0
302	Fault	Fault	Fault indication	1 = Fault activated	1	0		0	1	0
303	W1LED	W1LED	W1 RED status LED	W1 RED status LED	1	0		0	1	0
304	W2LED	W2LED	W2 GREEN status LED	W2 GREEN status LED	1	0		0	1	0
305	W3LED	W3LED	W3 YELLOW status LED	W3 YELLOW status LED	1	0		0	1	0
307	PreWarningFlag	PreWarning flag	Indicator of whether the warning threshold has been exceeded	1 = warning threshold exceeded	1	0		0	1	0
308	WarningFlag	Warning relay	Warning activation indicator including delay	1 = Warning ON	1	0		0	1	0
309	AlarmFlag	Alarm relay	Alarm activation indicator including delay	1 = Alarm on	1	0		0	1	0
310	BTStatus	BTStatus	Bluetooth status	1 = Bluetooth on	1	0		0	1	0
311	SensorExpired	Sensor expired	Flag showing if the sensor needs to be replaced	1 = sensor to be replaced	1	0		0	1	0
312	DeviceUnlocked	Device unlocked	Indicator for authorisation to modify variables	1 = unlocked	1	0		0	1	0

**Input register 102 : bits**

Bit	Description	Long description	Fault	Service Port Error Code
0	No reply from SM		Yes	1 V
1	No reply from sensor		Yes	2 V
2	Preheating	From sensor, 1 during preheating		
3	Reserved	Internal use only		
4	Over range	Over range from sensor		5 V
5	Under range	Under range from sensor	Yes	3 V
6	Reserved	For internal use only		
7	Reserved	For internal use only		
8	Reserved	For internal use only		
9	Reserved	For internal use only		
10	ServiceDue	SM reporting service due		
11	SensorExpired	SM reporting sensor expired		
12	N/A			
13	Reserved	For internal use only		
14	Reserved	For internal use only		
15	N/A			

**Function 05 Write Single Coil & Function 01 Read Coils**

Address	Register name	Short description	Medium description	Long description	Max value	Min value	Unit of meas.	Modbus Bit pos.	Modbus length	Default value
401	ServiceDue	Service needed	Maintenance indicator (Including calibration)	1 = maintenance required	1	0		0	1	0
402	Acknowledge	Acknowledge	Manually acknowledge warning or alarm	Write 1 to acknowledge	1	0		0	1	0
403	RelayFailSafe	Relay FailSafe	Relay in failsafe mode	1 = Relay in failsafe mode	1	0		0	1	0
404	RelayWF	Relay WF	Warning relay used as fault	1 = Warning relay used as fault	1	0		0	1	0
405	Acknowledge Warning	Acknowledge warning	Manual/automatic warning acknowledgement setting	1 = automatic reset; 0 = manual reset	1	0		0	1	0
406	Acknowledge Alarm	Acknowledge Alarm	Manual/automatic alarm acknowledgement setting	1 = automatic reset; 0 = manual reset	1	0		0	1	1
407	ZeroCalibration	Zero calibration	Start zero calibration command	1 = start calibration	1	0		0	1	1
408	SpanCalibration	SpanCalibration	Start span calibration command	1 = start span calibration	1	0		0	1	0
409	FactoryReset	Reset	Reset the detector to the factory settings	1 = restore factory settings	1	0		0	1	0



## 5 MAINTENANCE

### 5.1 Calibration procedure

The calibration procedure is performed periodically and involves introducing a known gas concentration at the sensor inlet, using the calibration kit.

The need to perform calibration is signalled by a specific variable on the supervisor. Each type of device has a different calibration interval, as described in the technical specifications table. After a few years of operation, the sensor needs to be replaced, as described in the following chapters, as the calibration is no longer sufficient to guarantee reliability of the measurement performed.

The CO<sub>2</sub> detectors do not require periodic calibration, but simply replacement of the sensor after approximately 7 years. Calibration can be performed every 12 months if wanting to guarantee greater accuracy of the measurement or if needing to issue a new calibration certificate. Below is a description of how to calibrate via the controller or via the app.

### 5.2 Calibration kit

The calibration kit is used to perform periodic calibration required for maintenance of the device. The gas cylinder and pressure adapter to perform the calibration need to be procured separately.



Calibration kit with adapter, humidifier



Use the calibration adapter supplied



Wet the filter core with tap water



Put the core back in place and close the filter. Note the direction of air flow (towards the sensor).  
Open the regulator on the gas cylinder and let the gas flow for approximately one minute without the calibration adapter connected to the sensor, then close the regulator.

### 5.3 Calibration via app

Before connecting to the device via the **SAMON GLACIÄR app**, first make sure that the BLUETOOTH connection and GEOLOCATION are enabled on the smartphone used.

Make sure that the Bluetooth mode on the **GLACIÄR MIDI** has been activated using the magnetic latch as described in the previous chapters.

Refer to the Functions chapter of the **SAMON GLACIÄR app** manual for details of all the app's features.

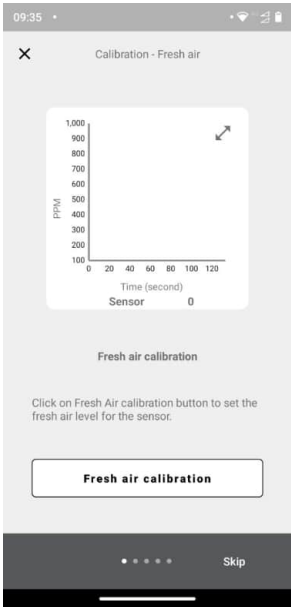
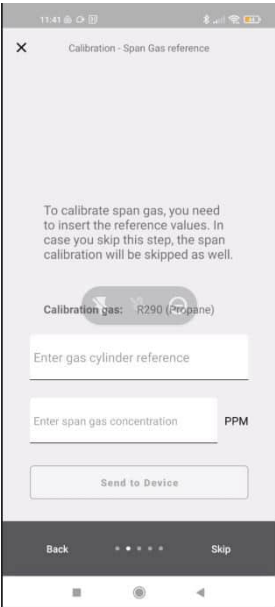
1	2
	
<p>Start calibration on the navigation bar. Make sure the sensor is ready and free of gas or other sources of pollution Click Fresh air calibration at the bottom right, then select Next</p>	<p>To perform the calibration, the specific gas indicated as the "calibration GAS" needs to be used. Enter the gas cylinder reference (serial number of the reference gas or other information to be shown on the certificate). Enter the concentration of the gas used for calibration. Click send to device to set the gas concentration used for calibration.</p>

3

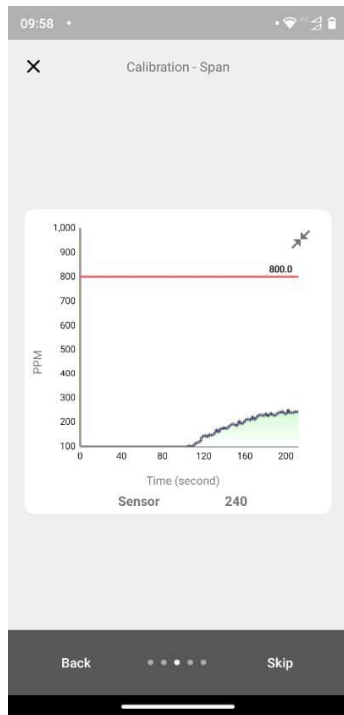

Supply the gas at the known concentration using the calibration kit. Wait about 1 minute until the gas concentration stabilises.

4

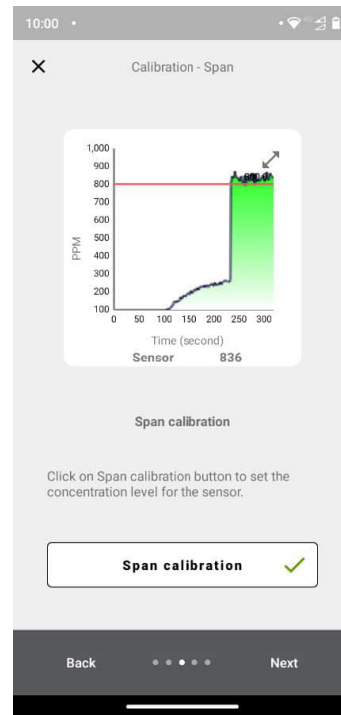

Click Span Calibration to set the calibration concentration.

5

Enter the room temperature and relative humidity. These values will be entered on the calibration certificate to indicate the environmental conditions during calibration. It is not necessary to use a calibrated instrument to perform this measurement, an indicative value is sufficient.

6

Verify the summary screen, checking that all the information has been entered correctly before generating the calibration report.

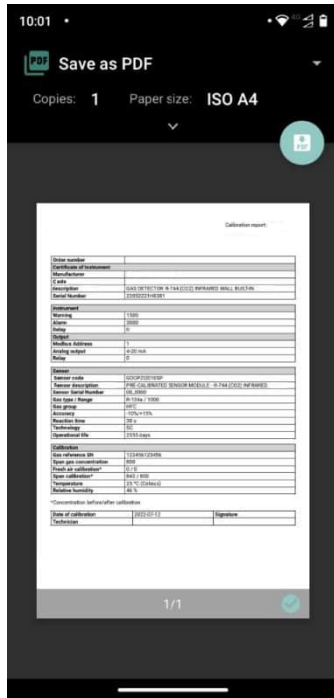

Save the calibration report.  
Use File manager to share the calibration report via email.

## 5.4 Calibration via Modbus® communication

Place the sensor in clean air and wait for the warm-up phase to be completed at the end of the start-up phase. Enter the Technician password to access the device (2222 to register 205).

Send 1 to ZeroCalibration (coil 407) to perform the fresh air calibration. If coil 407 is read as 0 after calibration, it means that calibration was successful.

Send the span gas concentration to the SpanConcentration variable (holding register 655).

Supply gas to the sensor. Use the calibration kit and a 0.5 l/min airflow regulator. Wait around 1 minute until the concentration is stable.

Send 1 to SpanCalibration (coil 408). Read as 0 to confirm the calibration was successful.

### 5.4.1 Diagram of the calibration procedure

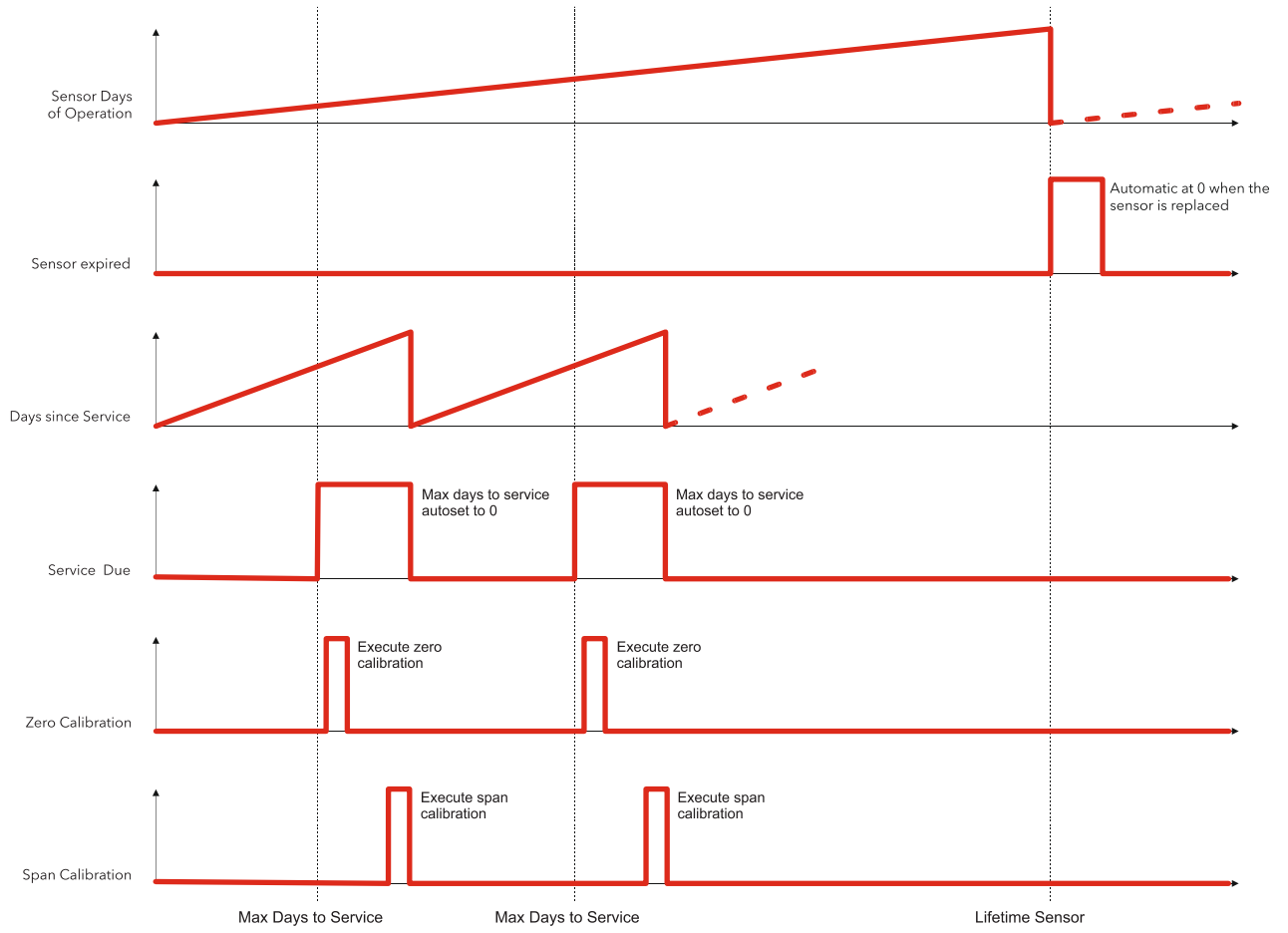

### 5.4.2 Operation of the registers for calibration

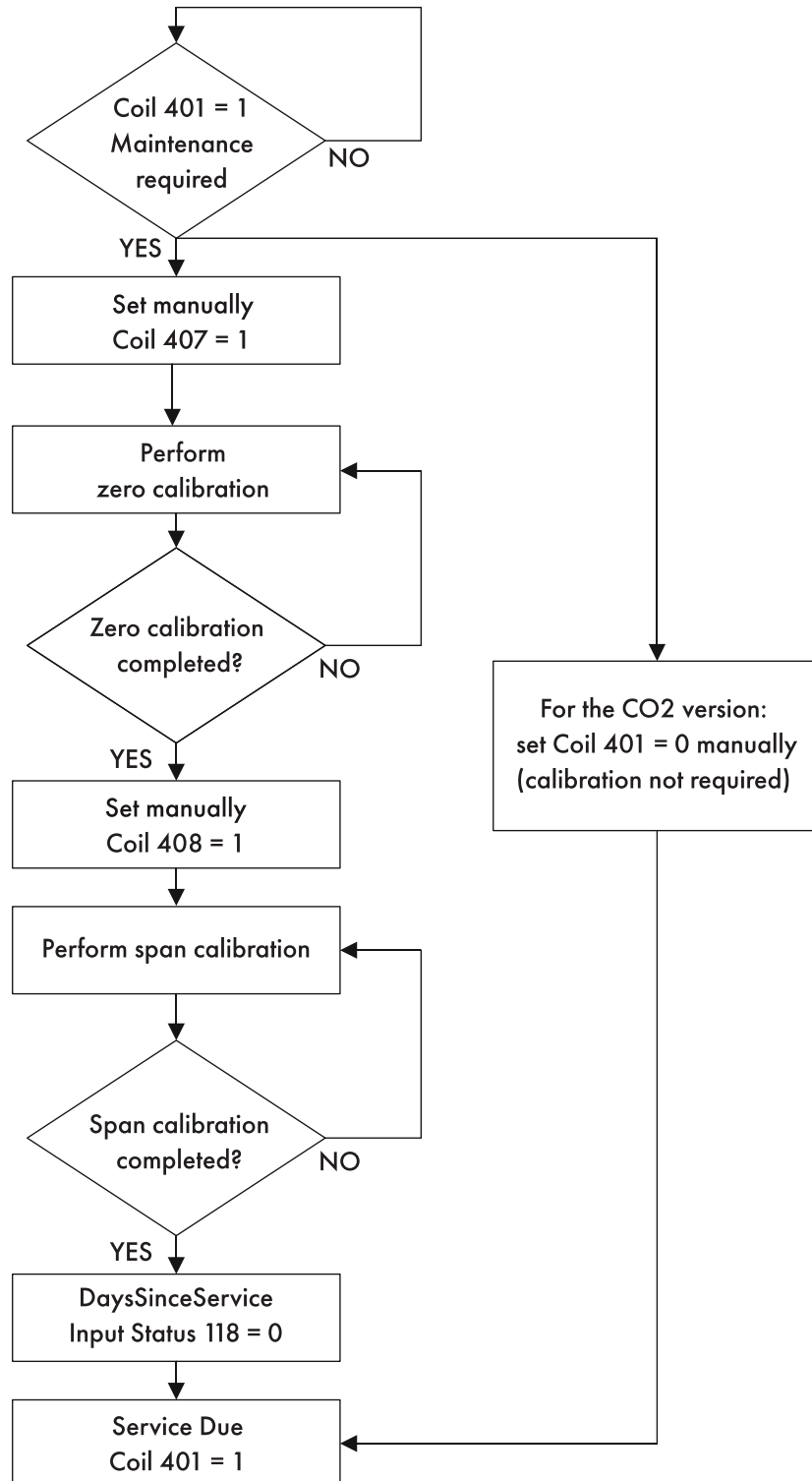

## 5.5 Sensor replacement procedure

When the need for replacement is signalled via Modbus communication (coil 311 SensorExpired), proceed as follows:

- Acquire a pre-calibrated sensor module with the same part number as the one mounted on the detector.
- Disconnect power

### **Built-in version**

- Open the cover
- Disconnect the sensor connector J7
- Unscrew the sensor module from the case
- Screw in the new sensor module
- Plug-in the sensor connector to terminal J7
- Close the cover

### **Remote version**

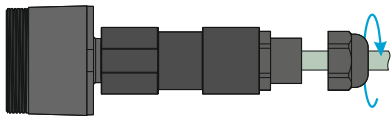

Loosen the cap off the cable gland so that the cable is free to move inside the cable gland.

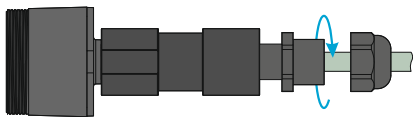

Completely unscrew the cable gland. In the event of difficulties when loosening, use pliers.

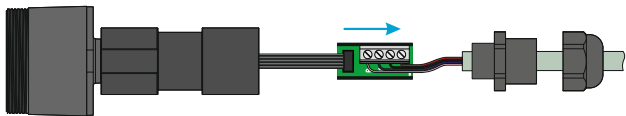

Pull out the electronic board from its housing by pulling the remote sensor cable



Unplug the sensor connector from the electronic board

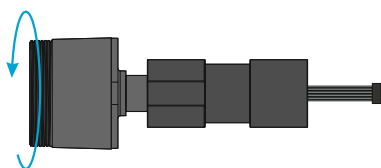

Unscrew the sensor module from the tube so as to separate it from the other parts of the device

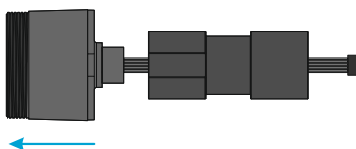

Pull out the sensor module

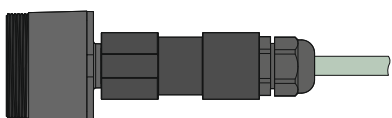

Make sure the new sensor module has the same part number as the one just removed. Mount the sensor module in the opposite order to the above instructions for removal.

## 5.6 Cleaning the device

---

Clean the detector with a soft cloth using water and a mild detergent. Rinse with water. Do not use alcohol, degreasers, sprays, polishes, detergents, etc.

## 6 FURTHER INFORMATION

### 6.1 Sensor operating principle

---

#### 6.1.1 Semiconductor sensors

Semiconductor or metal-oxide-semiconductor (MOS) sensors are very versatile and can be used in a wide range of applications: they can measure both gases and vapours at low ppm and combustible gases at higher concentrations. The sensor is made from a blend of metal oxides. These are heated to a temperature between 150 °C and 300 °C, depending on the gas to be detected. The operating temperature and composition of oxides determines the selectivity of the sensor with respect to different gases, vapours and refrigerants. Electrical conductivity increases significantly as soon as gas or vapour molecules come into contact with the sensor's surface by diffusion.

When the molecules of the selected gas come into contact with the sensor's surface, the conductivity of the semiconductor material increases significantly in proportion to the concentration of gas. Consequently, the current running through the sensor also varies. Water vapour, high ambient humidity, temperature fluctuations and low oxygen levels can alter the readings, giving a higher concentration than the actual level.

By using this technology, **GLACIÄR MIDI** allows the gas detected to be selected based on its category. Gases are divided into three categories or groups. Group 1 includes R32 gases, group 2 those HFCs/HFOs and group 3 HCs.

Depending on the gas to be detected, the specific device that detects that category of gas needs to be purchased, and then the specific gas selected via app or Modbus.

The table in the next chapter shows the list of gases detected and the corresponding group.

For example, if needing to detect R-410A, the required device needs to be purchased, described as "Group 1". At the time of installation, then, select R-410A via app or by setting the corresponding Modbus register.

#### 6.1.2 Electrochemical sensors

Electrochemical sensors measure the partial pressure of gases in atmospheric conditions. The monitored ambient air diffuses through a membrane into a liquid electrolyte inside the sensor. Immersed in the electrolyte are a measuring electrode, a counter electrode and a reference electrode. An electronic circuit with a potentiometer supplies a constant voltage between the measuring electrode and the reference electrode. The voltage, the electrolyte and the material used to make the electrodes are selected according to the gas being measured, so that this is correctly transformed electrochemically on the electrode for measurement and thus a current is generated that flows through the sensor. The current value is proportional to the concentration of gas. At the same time, oxygen from the ambient air reacts with the counter electrode. At an electronics level, the current signal is amplified, digitised and corrected based on other control parameters (e.g. ambient temperature).

#### 6.1.3 Pre-calibrated sensors and devices

Pre-calibrated sensors and devices are supplied with the calibration certificate included in the packaging, in addition to the instruction sheet.



**IMPORTANT:**

This product uses semiconductors that may be damaged by electrostatic discharges (ESD).

When handling printed circuit boards, observe proper ESD precautions so as to not damage the electronics.



## 6.2 Gas detected

Register 117 group	Gas group	Technology	Default GAS	Gas calibration
4	CO <sub>2</sub>	Infrared	CO <sub>2</sub>	CO <sub>2</sub>
5	NH <sub>3</sub>	Electrochemical	NH <sub>3</sub>	NH <sub>3</sub>
1	R32 mix Type 1	Semiconductor	R32	R32
2	HFC/HFO Type 2	Semiconductor	R134a	R134a
3	HC Type 3	Semiconductor	R290	R290

Gas	Sensor module group	Range of measurement.	GasType register value
R-1150	3	0-4000 ppm	53
R-1233zde	2	0-1000 ppm	51
R-1234yf	2	0-1000 ppm	27
R-1234ze	2	0-1000 ppm	28
R-1270	3	0-4000 ppm	13
R-134a	2	0-1000 ppm	2
R-22	2	0-1000 ppm	1
R-290	3	0-4000 ppm	7
R-32	1	0-1000 ppm	23
R-404A	2	0-1000 ppm	3
R-407A	1	0-1000 ppm	19
R-407C	1	0-1000 ppm	4
R-407F	1	0-1000 ppm	22
R-410A	1	0-1000 ppm	5
R-448A	1	0-1000 ppm	33
R-449A	1	0-1000 ppm	34
R-450A	2	0-1000 ppm	35
R-452A	1	0-1000 ppm	36
R-452B	1	0-1000 ppm	38
R-454A	1	0-1000 ppm	43
R-454B	1	0-1000 ppm	40
R-454C	1	0-1000 ppm	44
R-455A	1	0-1000 ppm	29
R-464A	1	0-1000 ppm	48
R-465A	1	0-1000 ppm	49
R-466A	1	0-1000 ppm	47
R-468A	1	0-1000 ppm	50
R-50	3	0-4000 ppm	52
R-507A	1	0-1000 ppm	54
R-513A	2	0-1000 ppm	39
R-600A	3	0-4000 ppm	9
R-717	5	0-100 ppm	10
R-744	4	0-10000 ppm	11

## 6.3 Technical specifications

Technical specifications	Semiconductor version	Electrochemical version	Infrared version
Power supply voltage **	24VDC/AC +/- 20%, 5W , 50/60Hz		
User interface	App with Bluetooth		
Analogue output:	4-20mA / 0-10V / 1-5V / 2-10V selected via software		
Serial communication:	Modbus® RS485 isolated slaves		
Digital output 1 SPDT:	Alarm - relay 1 A/24 VDC/AC, resistive load		
Digital output 2 SPDT:	Warning/FAULT - relay 1 A/24 VDC/AC, resistive load		
Relay failsafe	Yes, selectable		
Selectable delay:	0-20 min; 1-minute steps, selectable via Modbus register/app		
Hysteresis	± 10% of the threshold value		
IP protection:	IP67		
Typical operating range:	0-1000 ppm 0-4000 ppm	0-100 ppm	0-10000 ppm
Sensing element	Pre-calibrated (also available as a spare part) with certificate		
Remote cable length	5 metres		
Storage temperature	-40 °C to +50 °C.		
Storage humidity	5-90% relative humidity, non-condensing.		
Storage position	Any		
Operating temperature	-40 °C to +50 °C.		
Operating humidity	5-90% relative humidity, non-condensing.		
Maximum installation altitude	2000 metres		
Operating position	Intended for vertical mounting with the sensor at the bottom		
Precision*	<-10%/+15%	±5%	±5%
Start-up time*	5 minutes	5 minutes	2 minutes
Working life *	5 years	2 years	7 years
Calibration procedure requirements	12 months	12 months	Not required

\*Reference conditions at 25°C 50% RH atmospheric pressure 101.3 kPa

\*\* The device is intended to be supplied from an isolated Limited Energy Source per UL61010-1, 3rd edition cl. 9.4 or Limited Power Source per UL60950-1 or Class 2 per NEC

### 6.3.1 Mechanical specification

Dimensions	Enclosure size (W×H×D) (approx.)	Built-in: 233x175x97 mm
		Remote: 233x175x97 mm
Product weight + casing (approx.)		Built-in: 590 g
		Remote: 850 g

## 6.4 Disposal of the device

---

### 6.4.1 Disposal of electrical and electronic equipment

Since August 2012, rules governing the disposal of electrical and electronic equipment defined in European Directive 2012/19/ EU (WEEE) and national laws, which apply to this device, have been in force throughout the European Union. Common household appliances can be disposed of via special collection and recycling sites. However, this device has not been registered for home use. Therefore, it must not be disposed of using these services. Do not hesitate to contact **SAMON** if you have any further questions on this topic.

### 6.4.2 Disposal of the sensors

Dispose of the sensors in accordance with local laws.



**DANGER:** Do not throw the sensors into fire, due to the risk of explosion and consequent chemical burns.



**WARNING:** Do not force open the electrochemical sensors.



**WARNING:** Observe local regulations regarding waste disposal. For information, contact your local environmental agency, local government offices or appropriate waste disposal services.

### 6.4.3 Conformity to standards

- (EMC) 2014/30/EU
- (LVD) 2014/35/EU
- EN61010-1 | UL61010-1/CSA C22.2 No. 61010-1
- EN 378
- EN14624
- EN50270
- EN50271
- (RED-FCC) 2014/53/EU

## 7 ORDER INFORMATION

### 7.1 Gas Detector GLACIÄR MIDI series part numbers

Part number	Description	Sensor	Gas	Range
31-210-32	GLACIÄR MIDI IR CO2 10000 ppm	IR	CO2	0-10000 ppm
31-510-32	GLACIÄR MIDI Remote IR CO2 10000 ppm	IR - Remote	CO2	0-10000 ppm
	GLACIÄR MIDI IR CO2 50000 ppm	IR	CO2	0-50000 ppm
	GLACIÄR MIDI Remote IR CO2 50000 ppm	IR - Remote	CO2	0-50000 ppm
31-220-12	GLACIÄR MIDI SC HFC/HFO Group 1 1000 ppm	SC	HFC/HFO Group 1	0-1000 ppm
31-520-12	GLACIÄR MIDI Remote SC HFC/HFO Group 1 1000 ppm	SC - Remote	HFC/HFO Group 1	0-1000 ppm
31-220-17	GLACIÄR MIDI SC HFC/HFO Group 2 1000 ppm	SC	HFC/HFO Group 2	0-1000 ppm
31-520-17	GLACIÄR MIDI Remote SC HFC/HFO Group 2 1000 ppm	SC - Remote	HFC/HFO Group 2	0-1000 ppm
31-290-13	GLACIÄR MIDI SC R290 HC 4000 ppm	SC	R290 / HC	0-4000 ppm
31-590-13	GLACIÄR MIDI Remote SC R290 HC 4000 ppm	SC - Remote	R290 / HC	0-4000 ppm
31-250-22	GLACIÄR MIDI EC NH3 100ppm	EC	NH3	0-100 ppm
31-550-22	GLACIÄR MIDI Remote EC NH3 100 ppm	EC - Remote	NH3	0-100 ppm
31-250-23	GLACIÄR MIDI EC NH3 1000 ppm	EC	NH3	0-1000 ppm
31-550-23	GLACIÄR MIDI Remote EC NH3 1000 ppm	EC - Remote	NH3	0-1000 ppm
31-250-24	GLACIÄR MIDI EC NH3 5000 ppm	EC	NH3	0-5000 ppm
31-550-24	GLACIÄR MIDI Remote EC NH3 5000 ppm	EC - Remote	NH3	0-5000 ppm

### 7.2 Sensor module spare part numbers

SAMON part number	Description
	Pre-calibrated sensor module GLACIÄR - R-744 (CO2) infrared 10000 ppm
	Pre-calibrated sensor module GLACIÄR - R-744 (CO2) infrared 50000 ppm
	Pre-calibrated sensor module GLACIÄR - R-717 (ammonia) electrochemical 100 ppm
	Pre-calibrated sensor module GLACIÄR - R-717 (ammonia) electrochemical 1000 ppm
	Pre-calibrated sensor module GLACIÄR - R-717 (ammonia) electrochemical 5000 ppm
	Pre-calibrated sensor module GLACIÄR - group 1 semiconductor
	Pre-calibrated sensor module GLACIÄR - group 2 semiconductor
	Pre-calibrated sensor module GLACIÄR - group 3 semiconductor

### 7.3 Accessories

SAMON P/N	Description
	GAS DETECTOR - CALIBRATION KIT FOR GLACIÄR MIDI









Manufactured by:

**Samon AB**

Modemgatan 2  
S-235 39 Vellinge,  
Sweden

[www.samon.se](http://www.samon.se)